

INSTRUCTION MANUAL

PCX-MAT SERIES

POWER SUPPLY

PLUG-IN MODULAR POWER SUPPLY

KEPCO INC.
An ISO 9001 Company.

MODEL		
PCX-MAT SERIES		
POWER SUPPLY		
<input type="text" value="ORDER NO."/>	<input type="text" value="REV. NO."/>	

NOTE: This on-line version of the Technical Manual includes only installation and operating instructions. For the complete manual, please contact Kepco.

©2000, KEPCO, INC.



KEPCO®

THE POWER SUPPLIER™

KEPCO, INC. 1 131-38 SANFORD AVENUE 1 FLUSHING, NY. 11352 U.S.A. 1 TEL (718) 461-7000 1 FAX (718) 767-1102
email: hq@kepcopower.com 1 World Wide Web: <http://www.kepcopower.com>

TABLE OF CONTENTS

SECTION I – INTRODUCTION

PARAGRAPH	PAGE
1-1	Scope of Manual 1-1
1-3	General Description 1-1
1-8	Accessories 1-1
1-11	Specifications, General 1-2
1-12	Specifications, Performance 1-2
1-13	Specifications, Physical 1-2

SECTION II – INSTALLATION

2-1	Unpacking and Inspection 2-1
2-3	Terminations 2-1
2-4	AC Power Requirements 2-1
2-7	Grounding 2-1
2-9	Isolation 2-1
2-13	Preliminary Check-Out Procedure 2-2
2-15	Installation 2-2
2-17	Cooling 2-2

SECTION III – OPERATION

3-1	Standard Operation, Local Control 3-1
3-5	Remote Error Sensing 3-1
3-8	Introduction to Remote Programming 3-2
3-10	Equations Showing the Operation of the Kepco Bridge 3-2
3-12	Adjustments for Exact Programming Ratio 3-2
3-23	Programming Output Voltage with Resistance 3-4
3-26	Constant Current Operation 3-4
3-31	Programming with Conductance 3-5

3-35	Programming Output Voltage with External Voltage 3-6
3-40	Series Operation of PCX/PCX–MAT Modules 3-7
3-43	Parallel Operation of PCX/PCX–MAT Modules 3-7

SECTION IV – THEORY OF OPERATION

4-1	General 4-1
4-3	Detailed Circuit Description 4-1

SECTION V – MAINTENANCE

5-1	General 5-1
5-3	Disassembly 5-1
5-5	Installation and Adjustment of Optional Control Components 5-1
5-11	Current Limit Adjustment 5-2
5-13	Trouble Shooting 5-2
5-16	Performance Measurements 5-3
5-18	DC Regulation Measurements (Voltage Mode) 5-3
5-19	DC Regulation Measurements (Current Mode) 5-4
5-20	Interchange of PCX/PCX–MAT and PBX/PBX–MAT Modules 5-5/5-6

SECTION VI – PARTS LIST AND DIAGRAMS

6-1	General 6-1/6-2
6-3	Ordering Information 6-1/6-2

LIST OF ILLUSTRATIONS

FIGURE	PAGE
1-1	Kepco PCX and PCX-MAT Plug-In Modules -iii-
1-2	Kepco Enclosures and Hardware Systems . . -iv-
1-3	Mechanical Outline 1-4
2-1	Front Panel Terminations, PCX-MAT 2-1
2-2	Rear Terminations PCX/PCX-MAT 2-1
2-3	Conversion to 230V AC Line Operation . . . 2-1
2-4	Operation Check, PCX Group 2-2
3-1	Rear Connections for Standard Operation 3-1
3-2	Load Connection with Remote Error Sensing 3-1
3-3	Kepco Power Supply and Comparison Bridge Circuit 3-2
3-4	Programming Ratio Calibration, Method #1 3-3
3-5	Programming Ratio Calibration, Method #2 3-3
3-6	Programming Ratio Calibration, Method #3 3-4
3-7	Connections for Resistance Programming . . 3-4
3-8	Connections for Constant Current Operation 3-5
3-9	Connections for Conductance Programming 3-6
3-10	Connections for Voltage Programming 3-6
3-11	Series Connection of PCX/PCX-MAT Supplies 3-7
3-12	Parallel Operation, PCX/PCX-MAT Power Supplies 3-7
3-13	Parallel Connection of PCX/PCX-MAT Supplies 3-8

3-14	MASTER/SLAVE Parallel Connection 3-8
4-1	PCX/PCX-MAT Power Supply Module, Simplified Diagram 4-1
5-1	Disassembly, PCX/PCX-MAT 5-1
5-2	Location of Mounting Spaces for Optional Controls 5-1
5-3	Test Set-Up for Voltage Regulation Measurements 5-4
5-4	Test Set-Up for Current Regulation Measurements . . . 5-5/5-6
5-5	Application of the 4-Terminal Network Technique for Power Supply Measurements 5-5/5-6
6-1	Component Location, Printed Circuit Board 6-7
6-2	Component Location, Main Chassis 6-8
6-3	Main Schematic 6-9/6-10

LIST OF TABLES

TABLE	PAGE
1-1	Output/Input Specifications, PCX/PCX-MAT Power Supply Modules 1-3
1-2	Performance Specifications, PCX/PCX-MAT Power Supply Modules 1-3
2-1	Internal Controls 2-1

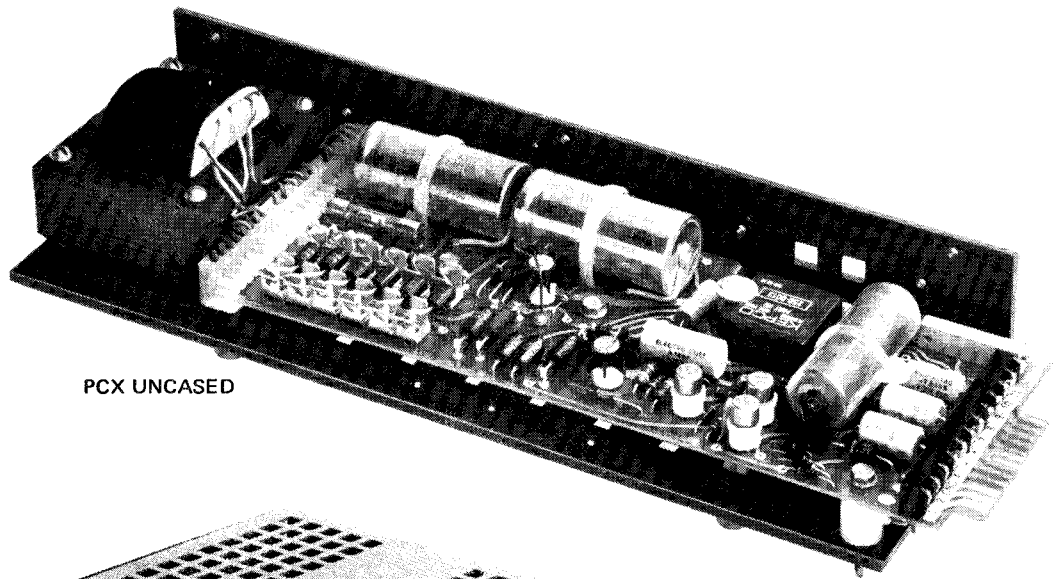

PCX UNCASD

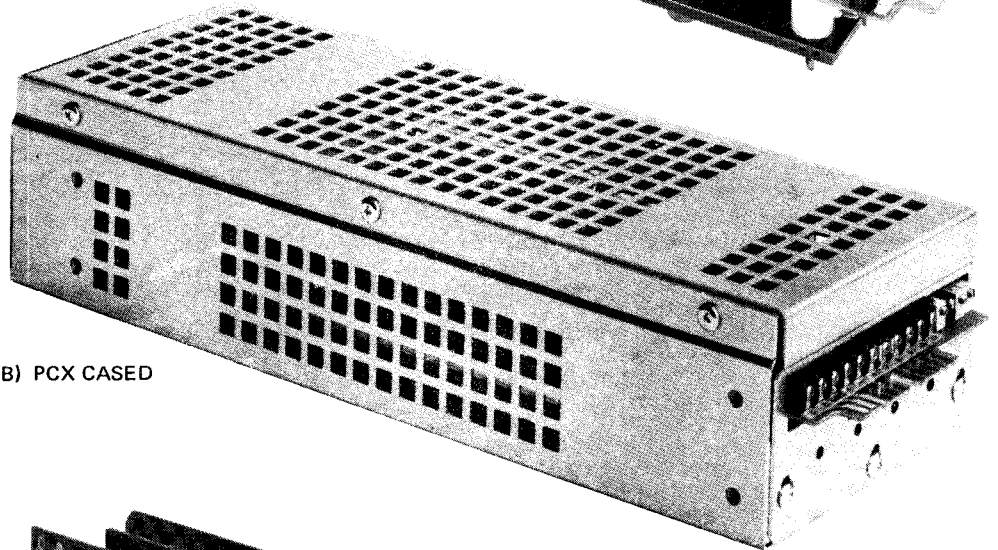

B) PCX CASD

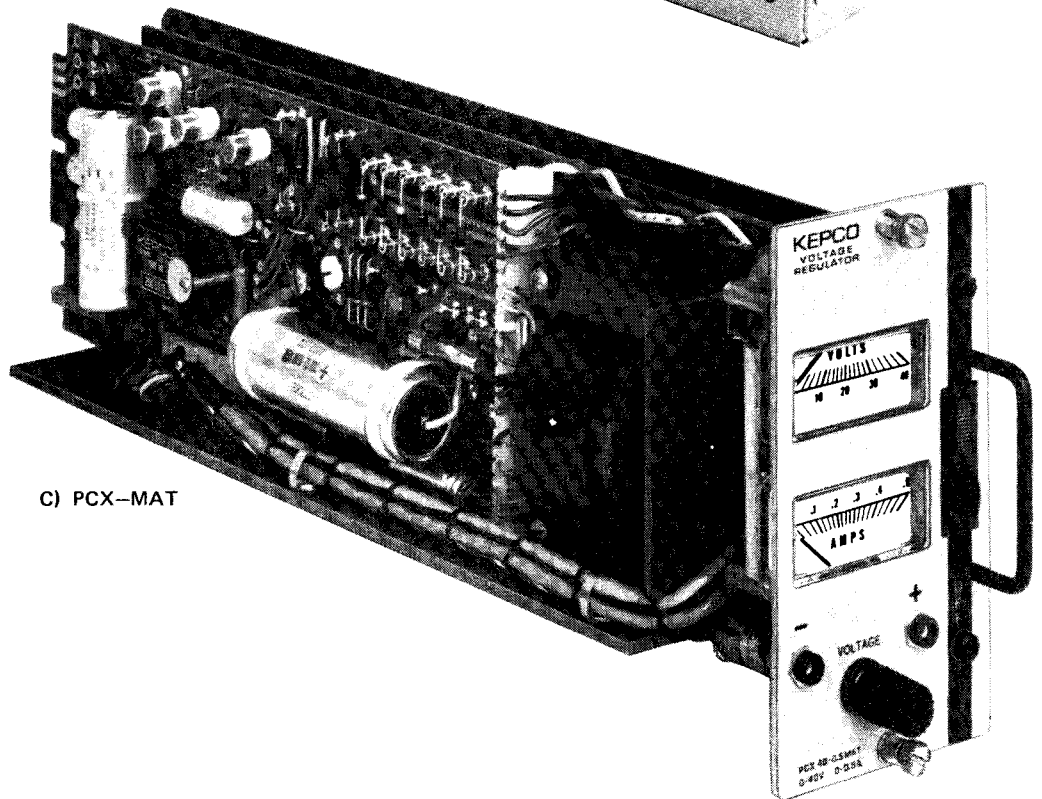

C) PCX-MAT

FIG. 1-1 KEPCO PCX AND PCX-MAT PLUG-IN MODULES

FIG. 1-2 KEPCO ENCLOSURES AND HARDWARE SYSTEMS

FOR PLUG-IN MODULES

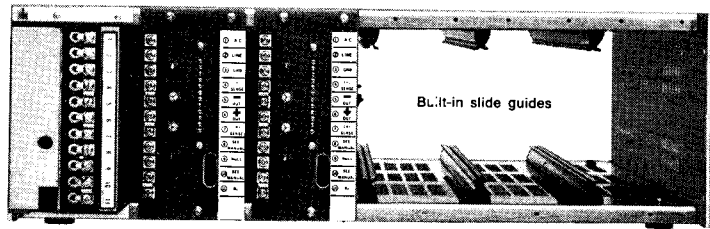

Rear view of the RA 22-6 Housing with one VP-PX Overvoltage Protector mounted (on far left) and 2 PC-2 Connectors installed

PLUG-IN CONNECTOR BOARD Model PC-2
One PC-2 must be ordered for each active slot in the RA 22-6.

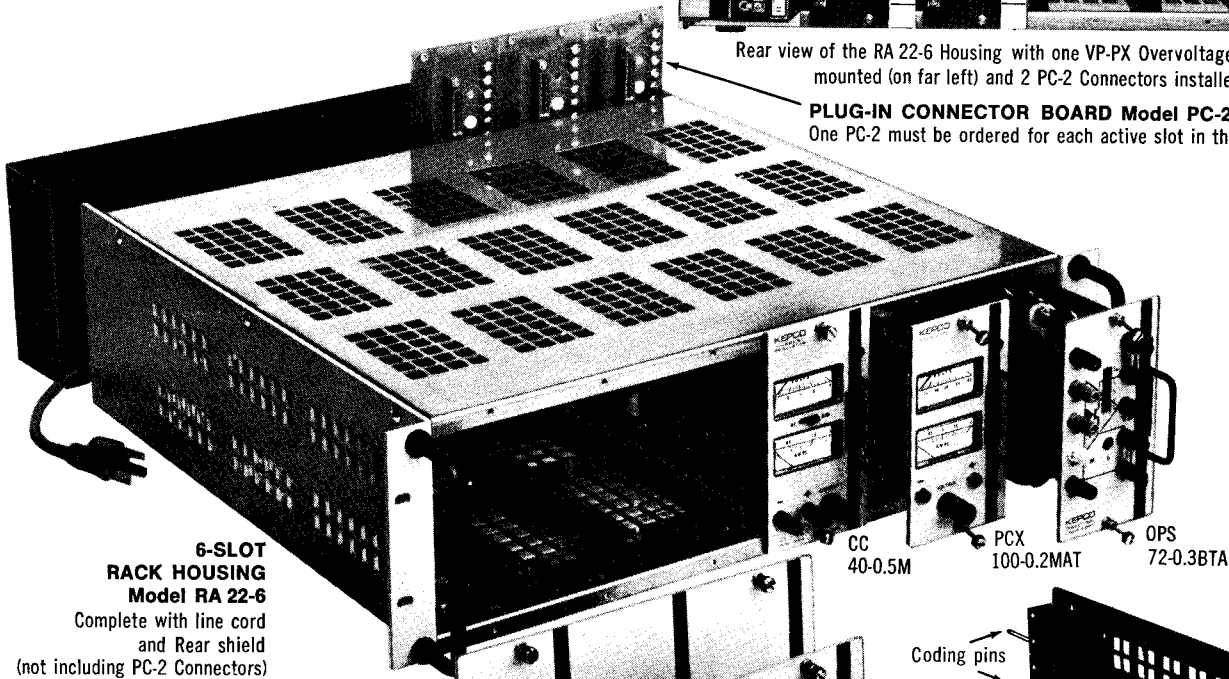

6-SLOT RACK HOUSING Model RA 22-6

Complete with line cord and Rear shield (not including PC-2 Connectors)

CC 40-0.5M PCX 100-0.2MAT OPS 72-0.3BTA

FILLER PANELS
(supplied without slide assembly and handle), may be used to fill unused slots in CA-3, CA-4, CA-5 and RA 22-6.

MODEL RFP 22-3

MODEL RFP 22-2

MODEL RFP 22-1

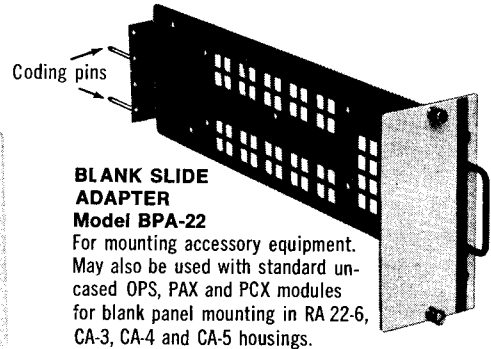

BLANK SLIDE ADAPTER Model BPA-22

For mounting accessory equipment. May also be used with standard uncased OPS, PAX and PCX modules for blank panel mounting in RA 22-6, CA-3, CA-4 and CA-5 housings.

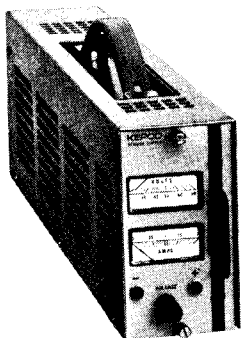

SINGLE UNIT HOUSING Model CA-3
Supplied complete with a built-in PC-2 connector. (shown with a PCX 100-0.2MAT plugged-in)

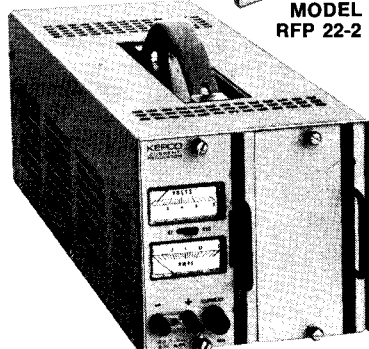

DOUBLE UNIT HOUSING Model CA-4
Supplied complete with a built-in dual PC-2 connector. (shown with a CC 40-0.5M and a BPA-22 plugged-in)

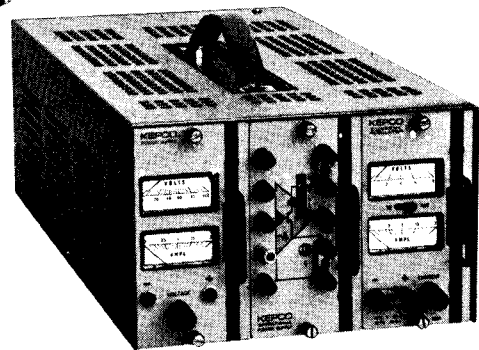

TRIPLE UNIT HOUSING Model CA-5
Supplied complete with a triple PC-2 connector.

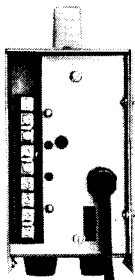

Typical rear view of CA-3, showing access terminals and connector.

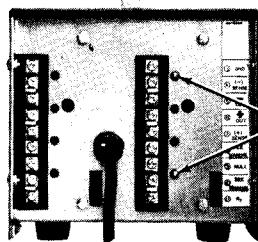

Typical rear view of CA-4, showing integral connector (Double PC-2) supplied.

All plug-in models and the BPA-22 are supplied with two coding pins that can be arranged in 6 different patterns to key the housing slots.

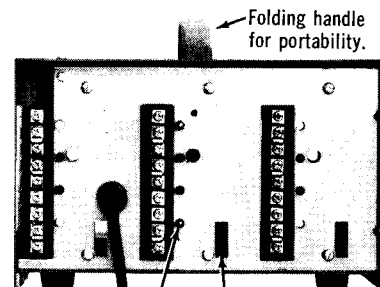

Typical rear view of CA-5, showing Slot provides access to internal coding pins, connectors and line cord. Folding handle for portability.

SECTION I – INTRODUCTION

1-1 SCOPE OF MANUAL

- 1-2 This manual contains instructions for the installation, operation and maintenance of the Kepco Series PCX and PCX–MAT Regulated DC Power Supplies.

1-3 GENERAL DESCRIPTION

- 1-4 The PCX and PCX–MAT Series represent a group of tightly regulated, low ripple power supplies of modular construction. While the PCX group is delivered as a power supply module without metering or controls, the PCX–MAT series is equipped with a functional front panel, containing full output metering, a ten-turn voltage control and AC input power switch and indicator. The two groups are identical with respect to their rear-terminal layout, electrical design and specifications. Interchange of PCX/PCX–MAT Models with similar rated models of the former Kepco Groups PBX/PBX–MAT is made possible by providing jumper connections on the PCX/PCX–MAT models. See Section V of this manual for details.
- 1-5 The PCX and PCX–MAT Series of power supplies feature a plug-in type, monolithic integrated circuit amplifier, specifically adapted to the critical needs of a power supply regulator. The amplifier provides a significant improvement over discrete component amplifiers especially in the DC power supply parameters. Other design features include a sharp current limit circuit, adjustable in the range from 10 to 105% of the rated output current, which protects the connected load and renders the PCX power supply completely short-circuit proof. Rear terminations on the PCX and PCX–MAT power supplies provide for AC input, DC output with "error sensing" and programming connections for remote output voltage control by resistance, voltage or current. In addition, PCX–MAT power supplies are equipped with additional front panel output terminals.
- 1-6 Optional accessories for the PCX models include a "Bridge Current Control" (Models with suffix "R") and a "Zero Control" (Models with suffix "E") which allow precision programming ratio adjustment. Models with suffix "T" have special reference sources and feature an all over temperature coefficient of 0.005% per degree centigrade.
- 1-7 The modular construction of the PCX and PCX–MAT power supplies permits installation in a variety of mounting accessories (Refer to FIG. 1-2 and paragraph 1-8) or the power supply module may be installed as an integral part of an existing installation.

1-8 ACCESSORIES

- 1-9 GENERAL. PCX and PCX–MAT modules are supplied without AC line cords. AC input connections (and DC output or programming connections) must therefore be made by means of one of the methods listed below:
- Using any of the listed Kepco mounting accessories, all of which are equipped with AC line cords and mating adaptors for PCX and PCX–MAT power supply modules. The power supply output, sensing and programming terminals are made available at the rear-barrier strips of the chosen case or rack-cabinet.
 - If none of the Kepco mounting accessories are used, the printed circuit connector of the PCX or PCX–MAT power supply may be terminated with a mating jack, to which all necessary connections must be wired.
 - (PCX Models only.) All AC input, DC output and programming connections may be wired directly to the rear barrier strip. PCX models have a fixed control resistor across barrier strip terminals (7) and (8). This resistor is for preliminary checking purposes only and must be replaced by a high quality, wirewound control resistor as described in the operating section of this manual. (Refer to Section III.)
- 1-10 ENCLOSURES AND MOUNTING HARDWARE FOR KEPCO MODULAR SUPPLIES (OPTIONAL, not supplied with power supply. Refer to FIG. 1-2 for illustrations of the Kepco Hardware System.
- MATING CONNECTOR, for uncased operation: KEPKO Model PC-1 or, METHODE Model CD-612-S-P7 (not shown).
 - SINGLE SLOT HOUSING, accepts single PCX module and provides all necessary rear terminations. KEPKO Model CA3. (AC Line Cord included).
 - DOUBLE SLOT HOUSING. KEPKO Model CA4, accepts two PCX modules or mixtures.* Rear terminations provided. (AC Line Cord included)
 - TRIPLE SLOT HOUSING, KEPKO Model CA5, accepts three PCX modules or mixture.* Rear terminations provided. (AC Line Cord included).
 - RACK CABINET, KEPKO Model RA 22–6, accepts six PCX modules or mixture.* Each mounted unit needs a plug-in adaptor (f). (AC Line Cord included)
- *NOTE: Multiple slot housings will accept a mixture of Kepco modular units (OPS–BTA, PCX–MAT) as well as blank-panel inserts such as BPA and RFP.

- f) PLUG-IN ADAPTOR, KEPCO Model PC2, required for rack-mounting each plug-in module.
- g) FRONT PANEL, KEPCO Model BPA-22, blank panel with slide bracket for fitting accessory equipment or other Kepco modular unit without front panel attachments.
- h) FILLER PANELS
 - 1) KEPCO Model RFP 22-1, to cover one (1) empty slot in rack cabinet (RA 22-6) or one of the multiple slot housings (CA4,CA5).
 - 2) KEPCO Model RFP 22-2, to cover two (2) empty slots.
 - 3) KEPCO Model RFP 22-3, to cover three (3) empty slots.
- i) CASE, KEPCO MODEL CA -1, for PCX models only.
- j) RACK ADAPTOR (for encased PCX models), KEPCO MODEL RA 12-1, for one unit (not illustrated).
- k) RACK ADAPTOR (for encased PCX models), KEPCO MODEL RA 13-4, for four units (not illustrated).
- l) RACK ADAPTOR (for encased PCX models), KEPCO MODEL RA 11-6, for six units (not illustrated).

1-11 SPECIFICATIONS, GENERAL

- a) AC INPUT: 105 V to 125 V AC or 210 V to 250 V AC (selectable), 50 to 440 Hz, single phase. Input current: Refer to Table 1-1.
- b) AMBIENT OPERATING TEMPERATURE: -20°C to $+65^{\circ}\text{C}$.
- c) STORAGE TEMPERATURE: -40°C to $+85^{\circ}\text{C}$.
- d) ISOLATION: 500 Volts maximum (DC or p-p) may be connected from chassis to either output terminal.

1-12 SPECIFICATIONS, PERFORMANCE

- a) DC OUTPUT: Refer to Table 1-1.
AC INPUT: Refer to Table 1-1.
- b) Output effect specifications for both operating modes are presented in Table 1-2.

1-13 SPECIFICATIONS, PHYSICAL

- a) Refer to FIG. 1-3, "Mechanical Outline Drawing", for dimensions, materials used, and finish.

NOTE: With the introduction of the 1970 Catalog (B-703), Kepco has adopted new technical terms recommended by the International Electrotechnical Commission (IEC). These terms replace or supplement previously used expressions, mainly to avoid difficulties in translation and prevent erroneous interpretations at home and abroad.

As a beginning, Kepco will discontinue the use of the specifications entitled "Line Regulation" and "Load Regulation" because of the long standing (and misleading) connotation that a power supply regulates the line or the load. Instead, Kepco will follow the recommendation of the IEC and speak of the "Output Effects, caused by changes in the Influence Quantities." The "Output Effects" are specified as before, either as a percentage change referred to the maximum specified output voltage (E_0) or current (I_0) or as an absolute change (ΔE_0 , ΔI_0) directly in millivolts or milliamperes or both. The "Influence Quantities" are the "Source Variations" (formerly a-c line variations), the changes in load, temperature or time as previously specified. The illustration below will clarify the use of the new terminology.

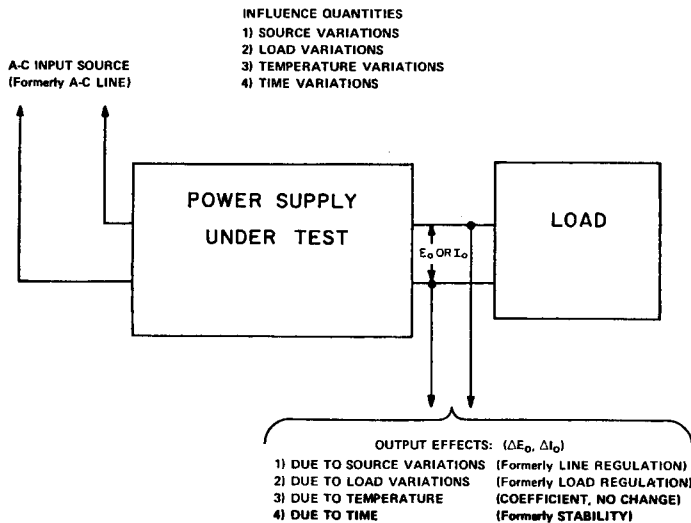

MODEL	D-C OUTPUT RANGE		OUTPUT IMPEDANCE OHMS + MICROHENRIES			AC INPUT MAX.INPUT AMPS at 125 V A-C
	VOLTS	AMPS	DC TO 100 HZ	100 HZ TO 100 KHZ	1KHZ TO 100 KHZ	
PCX 7-2	0-7	0-2	0.2×10^{-3}	0.02	$0.1 + 1\mu\text{h}$	0.50
PCX 7-2MAT	0-7	0-2	0.2×10^{-3}	0.02	$0.1 + 1\mu\text{h}$	0.50
PCX 15-1.5	0-15	0-1.5	0.5×10^{-3}	0.02	$0.1 + 1\mu\text{h}$	0.65
PCX 15-1.5MAT	0-15	0-1.5	0.5×10^{-3}	0.02	$0.1 + 1\mu\text{h}$	0.65
PCX 21-1	0-21	0-1	1×10^{-3}	0.02	$0.1 + 1\mu\text{h}$	0.45
PCX 21-1MAT	0-21	0-1	1×10^{-3}	0.02	$0.1 + 1\mu\text{h}$	0.45
PCX 40-0.5	0-40	0-0.5	4×10^{-3}	0.02	$0.1 + 1\mu\text{h}$	0.40
PCX 40-0.5MAT	0-40	0-0.5	4×10^{-3}	0.02	$0.1 + 1\mu\text{h}$	0.40
PCX 72-0.3	0-72	0-0.3	12×10^{-3}	0.02	$0.1 + 1\mu\text{h}$	0.45
PCX 72-0.3MAT	0-72	0-0.3	12×10^{-3}	0.02	$0.1 + 1\mu\text{h}$	0.45
PCX 100-0.2	0-100	0-0.2	25×10^{-3}	0.02	$0.1 + 1\mu\text{h}$	0.45
PCX 100-0.2MAT	0-100	0-0.2	25×10^{-3}	0.02	$0.1 + 1\mu\text{h}$	0.45
PCX 200-0.1	0-200	0-0.1	100×10^{-3}	0.02	$0.2 + 1\mu\text{h}$	0.45
PCX 200-0.1MAT	0-200	0-0.1	100×10^{-3}	0.02	$0.2 + 1\mu\text{h}$	0.45

TABLE 1-1 OUTPUT/INPUT SPECIFICATIONS, PCX, PCX-MAT POWER SUPPLY MODULES

SPECIFICATION	OUTPUT EFFECTS VOLTAGE MODE	OUTPUT EFFECTS CURRENT MODE**	VOLTAGE AMPLIFIER OFFSETS****		VOLTAGE REFERENCE (Internal)****
			OFFSET VOLTAGE ΔE_{i_o}	OFFSET CURRENT ΔI_{i_o}	
OUTPUT RANGE:	0-100% E_o max.	1 mA-100% I_o max.			Fixed 6.2V±5%
SOURCE: 105-125/210-150V AC	<0.0005%	<0.005%	<10 μV	<2 nA	0.0001%
LOAD: No load - full load	<0.005% or 0.2 mV*	<0.01%	<200 μV	<5 nA	
TIME: 8-hours (drift)	<0.01% or 1 mV*	<0.02	<20 μV	<2 nA	0.005%
TEMPERATURE: Per °C	<0.01%***	<0.02***	<20 μV	<5 nA	0.005%
RIPPLE: (rms)	<0.1 mV	<0.02% of I_o max.			

*Whichever is greater.

***"Rated Sample" is 1 volt DC across an external current sampling resistor having a temperature coefficient of 20 ppm (maximum). An external current control resistor with similar specifications must be used.

**PCX (PCX-MAT) Models with suffix "T" have a temperature coefficient of <0.005% of E_o max. per °C and <0.01% of I_o max. per °C in the respective operating modes.

***Offsets and the reference contribute to output effect ΔE_o , by the equation $\Delta E_o = \pm \Delta E_{\text{ref}}(R_f/R_i) \pm \Delta E_{i_o}(1 + R_f/R_i) \pm \Delta I_{i_o}(R_f)$ where R_f is the feedback resistor and R_i is the input resistor from the signal reference. Use the offsets to calculate output effects when external input/feedback elements are substituted for the internal reference and voltage control in programming applications.

TABLE 1-2 PERFORMANCE SPECIFICATIONS, PCX, PCX-MAT POWER SUPPLY MODULES

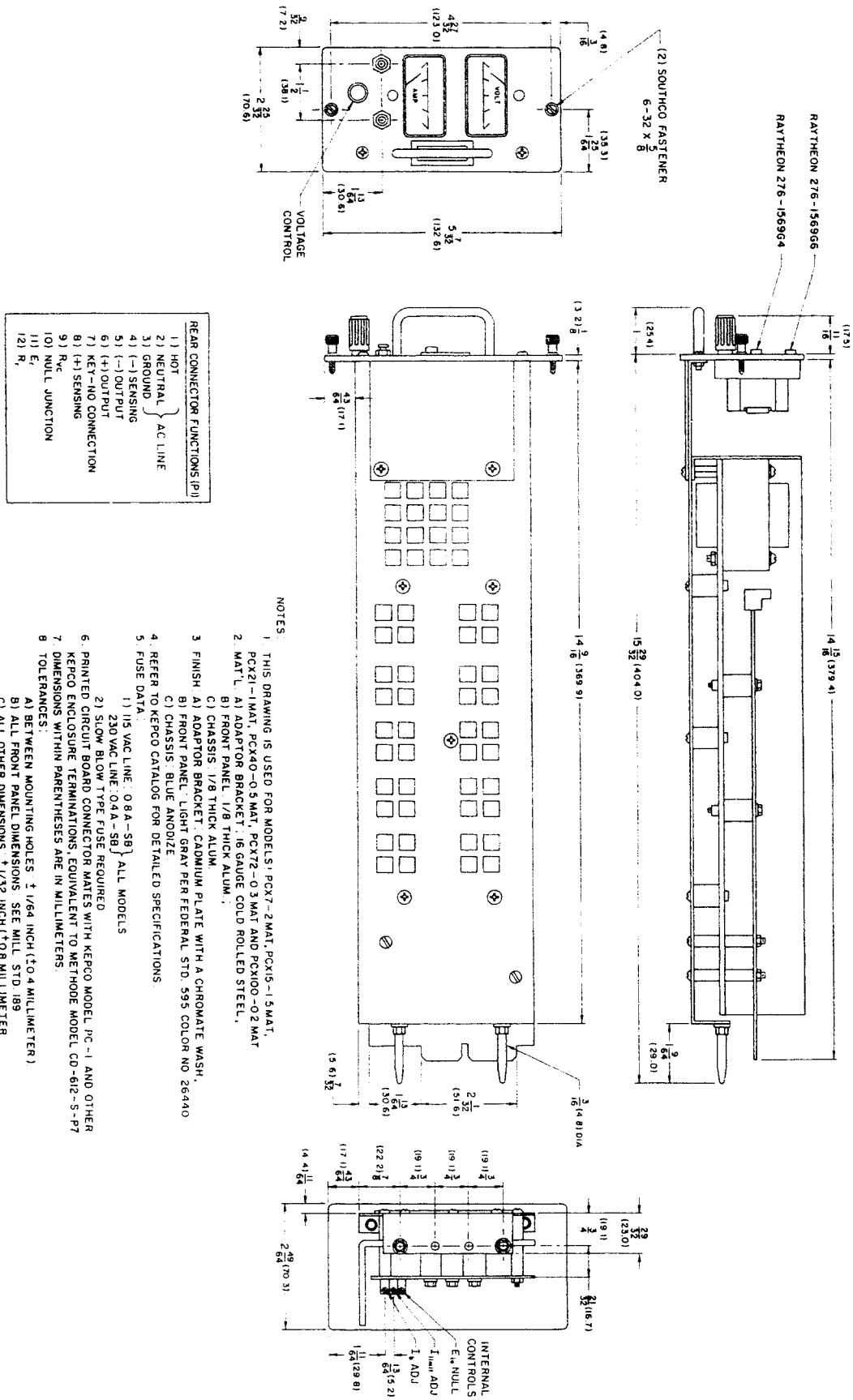

- NOTES:
- THIS DRAWING IS USED FOR MODELS: PCX7-2MAT, PCX15-1.5MAT, PCX21-1MAT, PCX40-0.5MAT, PCX72-0.3MAT AND PCX100-0.2MAT
 - MAT: A) ADAPTOR BRACKET, .16 GAUGE COLD ROLLED STEEL, B) FRONT PANEL, 1/8 THICK ALUM., C) CHASSIS, 1/8 THICK ALUM.
 - FINISH: A) ADAPTOR BRACKET, CADMIUM PLATE WITH A CHROMATE WASH, B) FRONT PANEL, LIGHT GRAY PER FEDERAL STD. 595 COLOR NO 26440 C) CHASSIS, BLUE ANODIZE
 - REFER TO KERCO CATALOG FOR DETAILED SPECIFICATIONS
 - FUSE DATA:
 - 1) 1/8 VAC LINE: 0.8A-58 } ALL MODELS
 - 2) 230VAC LINE: 0.4A-58 }
 - PRINTED CIRCUIT BOARD CONNECTOR MATES WITH KERCO MODEL PC-1 AND OTHER KERCO ENCLOSURE TERMINATIONS, EQUIVALENT TO METHODE MODEL CD-612-S-P7
 - DIMENSIONS WITHIN PARENTHESES ARE IN MILLIMETERS
 - TOLERANCES:
 - A) BETWEEN MOUNTING HOLES: ± 1/64 INCH (± 0.4 MILLIMETER)
 - B) ALL FRONT PANEL DIMENSIONS: SEE MILL. STD. 189
 - C) ALL OTHER DIMENSIONS: ± 1/32 INCH (± 0.8 MILLIMETER)

FIG. 1-3 MECHANICAL OUTLINE.

2-1 UNPACKING AND INSPECTION

2-2 This instrument has been thoroughly inspected and tested prior to packing and is ready for operation. After careful unpacking, inspect for shipping damage before attempting to operate. Perform the preliminary operational check as outlined in paragraph 2-11 below. If any indication of damage is found, an immediate claim with the responsible transport service must be entered.

2-3 TERMINATIONS

- a) FRONT PANEL: Refer to FIG. 2-1 (PCX—MAT only).
- b) REAR: Refer to FIG. 2-2.
- c) INTERNAL ADJUSTMENTS: Refer to Table 2-1.

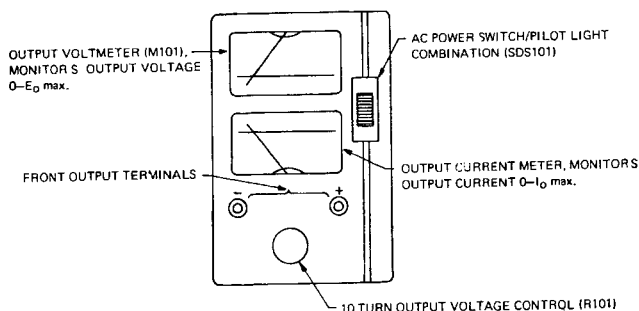

FIG. 2-1 FRONT PANEL TERMINATIONS, PCX—MAT

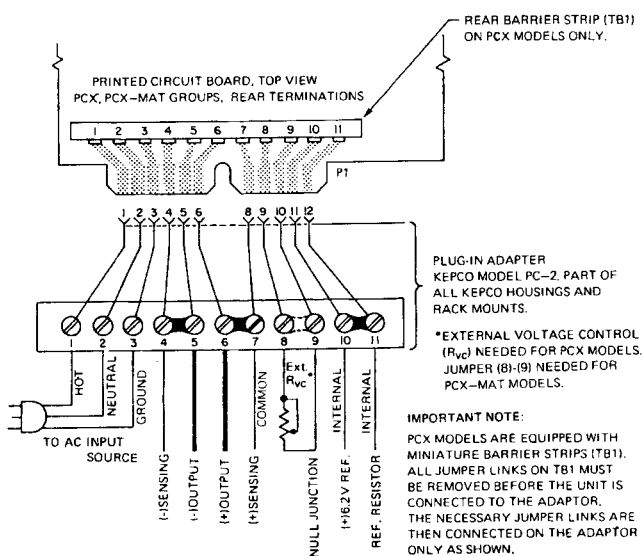

FIG. 2-2 REAR TERMINATIONS, PCX AND PCX—MAT GROUPS

REFERENCE DESIGNATION	ADJUSTMENT	PURPOSE	ADJUSTMENT PROCEDURE
R19	I _o LIMIT	OVERLOAD CURRENT CONTROL	PAR. 5-11
R24**	E ₁₀ NULLING	ZERO OFFSET VOLTAGE	PAR. 3-12
R25**	R _{vc}	VOLTAGE CONTROL	PAR. 5-10
R27***	I _b ADJUST	CONTROL CURRENT ADJUSTMENT	PAR. 3-12

*MODELS WITH PREFIX "8000" ONLY.
 **MODELS WITH SUFFIX "E" ONLY.
 ***MODELS WITH SUFFIX "R" ONLY.

TABLE 2-1 INTERNAL CONTROLS

2-4 AC POWER REQUIREMENTS

2-5 PCX and PCX—MAT power supplies are normally delivered for operation on a single phase, 105 to 125 V AC source, 50 to 65 Hz. For operation on 210 to 225 V sources, the jumper connections on the main transformer (T201) must be changed as shown in FIG. 2-3

2-6 PROCEDURE:

- a) Disconnect power supply from AC input source.
- b) Remove bare wire jumpers between terminals (A) and (B) as well as (C) and (D).
- c) Connect bare wire jumper between jumper terminals (B) and (C).
- d) Replace 0.8 A fuse with 0.4 A (Slow Blow Type).

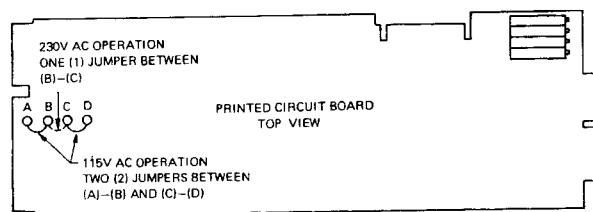

FIG. 2-3 CONVERSION TO 230 V AC LINE OPERATION

2-7 SAFETY GROUNDING

2-8 For safety reasons it is imperative that the metal chassis be kept at ground potential. If a three-wire safety line cord and a properly grounded outlet are used, this is taken care of automatically. However, if only a two-wire line cord or an adaptor for a three-wire line cord is used, the pigtail wire of the adaptor, or the metal chassis of the power supply (via P1-3) must be returned to a good AC ground.

2-9 SIGNAL GROUNDING

2-10 The negative output terminal of the PCX/PCX—MAT power supply is connected to the chassis via a resistor/capacitor network (R17, C5). If the power supply is therefore properly safety grounded (see par. 2-7), a signal ground is provided automatically. If this internal signal ground is not desired, either output side may be signal grounded externally. The internal grounding network may be opened by removing either R17 or C5 from the printed circuit board. (Refer to FIG. 6-1.)

2-11 ISOLATION

2-12 The DC output terminals of the PCX and PCX—MAT Power Supplies are isolated from the AC power line and from the chassis. Since no DC connection to the chassis exists, either side of the supply may be grounded, or a maximum of 500 V (DC or AC peak-to-peak) can be connected between chassis and either output terminal.

2-13 PRELIMINARY CHECKOUT PROCEDURE

2-14 Before final installation, a simple functional check may be performed as described below:

- a) PCX MODELS. Connect PCX to AC input power and connect a suitable DC voltmeter as shown in FIG. 2-4 below. The output voltage measured on the connected meter will be proportional to the resistance connected across terminals (8) and (9) of the rear barrier-strip on the power supply (TB1). Since a (nominal) 1 mA control current is used in PCX power supplies, the output voltage (E_O) will be approximately equal to the number of kilohms used times 1 mA.

The supplied carbon resistor connected across the barrier-strip terminals should not be used when making regulation or stability measurement. Instead it must be replaced by either a fixed or variable resistor having a temperature coefficient of not more than 20 parts per million. The value of the voltage control resistor to be selected depends upon the desired output voltage. For full output voltage control from zero to the maximum rated output voltage (E_O max.) the value of the variable control resistor (R_{VC}) should be:

$$R_{VC} \text{ (K-ohms)} = E_O \text{ max.} / 1 \text{ mA}$$

For example, the resistor value for Model PCX 100-0.2 would be:

$$R_{VC} \text{ (K-ohms)} = \frac{100V}{1 \text{ mA}} = 100 \text{ K ohm}$$

The selected value is connected across terminals TB1-8 and TB1-9. Full output control can now be exercised by varying R_{VC} from zero to full value. Remove AC input power. This concludes the preliminary checkout.

- b) PCX-MAT MODELS. Connect to mating device (either one of the accessories described in paragraph 1-8) and to AC input power. Turn AC POWER SWITCH "on". (Refer to FIG. 2-2 for the location of the front panel controls.) AC POWER INDICATOR light (part of AC POWER SWITCH) should energize. Turn VOLTAGE

CONTROL slowly clockwise and observe the increase of the output voltage on the panel meter (M101). The output should increase smoothly from zero to the maximum rated output voltage of the model under test. Shut AC POWER SWITCH "off." This concludes the preliminary checkout.

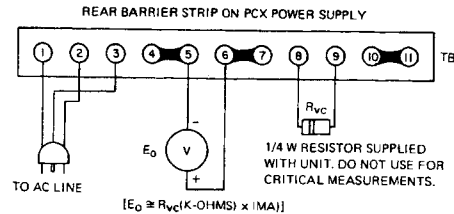

FIG. 2-4 OPERATION CHECK PCX

2-15 INSTALLATION

- 2-16 KEPCO modular, plug-in type power sources offer a wide variety of mounting possibilities (Refer to par. 1-8, "ACCESSORIES"). Whether single case, multiple housing or rack-installation is planned, installation consists simply in carefully sliding the module into one of the cabinets, making certain the printed circuit board connector of the unit has made positive contact with the mating plug in the housing.* Once the two holding screws on top and bottom of the front panel have been fastened, the unit is ready for operation.

2-17 COOLING

- 2-18 Modular units installed in single or multiple housings, or in rack cabinets must have sufficient air flow for effective convection cooling. Perforated side covers and tops must be kept clear from obstructions. In rack-installations, care must be taken that the temperature inside the rack does not exceed the specified ambient temperature. In extreme cases, the rack should be cooled by fans.

*NOTE: The distance from the outer edge of the printed circuit board connector to the rear of the front panel must be 15 inches $\pm 1/32"$. If it is not, loosen holding screws (See FIG. 5-1) and re-align for exact distance.

SECTION III – OPERATION

3-1 STANDARD OPERATION, LOCAL CONTROL (Refer to FIG. 3-1)

- 3-2 With the PCX or PCX-MAT power supply terminated either with a simple mating plug (PC-1) or the plug-in adaptor PC-2 (part of all mounting accessories), the unit may be connected to the AC input power and is ready for operation.
- 3-3 The load should be connected as shown (on PCX-MAT models, the load may be connected to the front terminals). Error sensing, as described below (Refer to paragraph 3-5) is recommended to insure specified performance directly at the load. Standard jumper link connections for local control are shown in FIG. 3-1 below. All load connections and jumper links must be tight and secure for proper operation. If the indicated Plug-In Adaptor (PC-2) is not used, the jumper links must be provided on the mating connector to P1. In the case of PCX Models which are equipped with their own miniature barrier strip (TB1), the jumper links on TB1 must be removed, if an adaptor (PC2-part of all cases and rack mounts) is used.

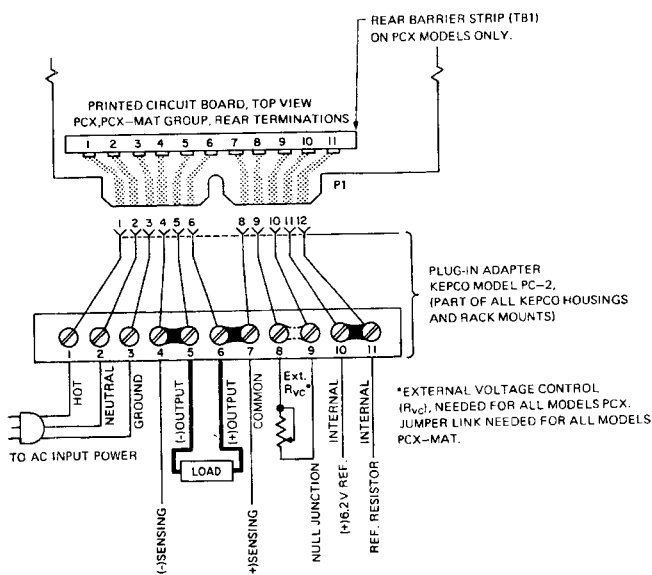

FIG. 3-1 REAR CONNECTIONS FOR STANDARD OPERATION

- 3-4 The connecting diagrams shown in the following paragraphs show ONE barrier strip only. This barrier strip represents the rear terminations of the PCX as well as that of the PCX-MAT group. The relationship between barrier strip terminals and pin numbers on P1 may be found by referring to FIG. 3-1. AC line connections (as shown in FIG. 3-1) have been omitted in order to simplify the presentation.

3-5 REMOTE ERROR SENSING

- 3-6 The error sensing leads are the input connections to the power supply's regulating system. They are terminated on terminals (4) and (7) of the adaptor plug barrier strip and normally connected to the output terminals (5) and (6) via removable links. With the links in place, specified regulation performance will be maintained at the rear output terminals of the power supply. Since the IR voltage drop across the load wires will degrade regulation at the load, the links connecting the sensing leads to the output terminals are now removed and the sensing terminals directly connected to the load.

3-7 PROCEDURE (Refer to FIG. 3-2)

- Remove jumper links between terminals (4)-(5) and (6)-(7).
- Use twisted wire, AWG#18 for the error sensing leads and twisted load wire as heavy as practicable, to reduce inductance and optimize transient recovery time. Observe polarities: The negative error sensing lead (4) must go to the negative load wire (5), the positive error sensing lead (7) to the positive load wire (6).

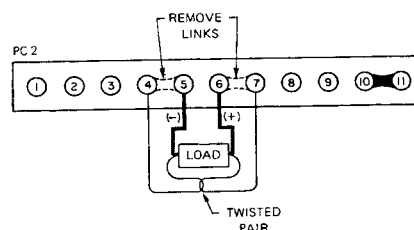

FIG. 3-2 LOAD CONNECTION WITH REMOTE ERROR SENSING

- NOTE: An accidental open circuit in the remote sensing circuit will sharply degrade the regulating function and cause the output voltage and ripple to rise. In addition, an open load circuit, leaving the error sensing terminals connected to the load, may be damaging to the supply since the load current will attempt to flow through the sensing circuit.

When using remote error sensing, the power supply should be OFF when the load and sensing connections are being made. Be sure to connect the load before connecting the sensing wires and conversely, remove the sensing wires before removing the load leads.

3-8 INTRODUCTION TO REMOTE PROGRAMMING (Refer to FIG. 3-3)

3-9 A few general remarks may be in order to familiarize the user of this equipment with the terminology and basic equations pertaining to remote programming of the Kepco PCX and PCX-MAT Power Supplies. Electrically, the power supply consists of the unregulated DC source (E_U) the pass element (E_P), the DC error amplifier (A) and a comparison circuit which resembles a four-arm electrical bridge. (Refer to FIG. 3-3). The elements of the bridge are arranged to produce a virtual zero at the amplifier input when the bridge circuit is at balance ($V_{AA}'=0$). Any tendency for the output voltage to change in relation to the reference voltage (R_r) creates an error signal which, by means of negative feedback and the amplifier, tends to correct the output voltage towards restoration of bridge balance.

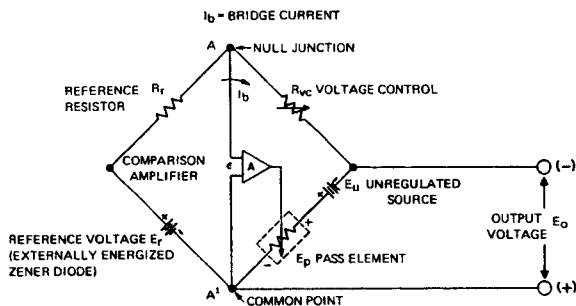

FIG. 3-3 KEPKO POWER SUPPLY AND COMPARISON BRIDGE CIRCUIT

3-10 EQUATIONS SHOWING THE OPERATION OF THE KEPKO BRIDGE

3-11 The following relationships govern the operation of the Kepco Bridge at balance, i.e., with $V_{AA}'=0$:

$$a) \frac{E_O}{E_r} = \frac{R_{VC}}{R_r} \quad (1)$$

$$\frac{E_r}{R_r} = I_b \quad (2)$$

$$E_O = I_b R_{VC} \quad (3)$$

Where: E_O = Output Voltage
 E_r = Reference Voltage
 R_r = Reference Resistance
 R_{VC} = Control Resistance
 I_b = Bridge Current

- b) The ratio of the number of ohms control-resistance needed per volt output is termed the "CONTROL RATIO". It is nominally 1000 ohm/Volt in the PCX and PCX-MAT Power Supplies.
- c) As can be seen from equation (1), the output voltage E_O can be controlled by varying any one of the three quantities. Rewriting equation (1) we have:

$$E_O = \frac{E_r}{R_r} \times R_{VC}$$

The ratio $\frac{E_r}{R_r}$ constitutes the bridge current

$$I_b. \quad E_r/R_r = I_b \quad (\text{Eq. 2})$$

- d) Therefore, we can write: $E_O = I_b R_{VC}$ (Eq.3). Making I_b a precision quantity (precision bridge current adjustment is described in Par. 3-12), establishes a precise programming ratio, so that the accuracy of E_O is solely dependent upon R_{VC} . This mode of operation is referred to as "RESISTANCE PROGRAMMING" and is covered in detail in Par. 3-23.
- e) Rewriting Equation (1), $E_O = E_r \frac{R_{VC}}{R_r}$
 we can make E_r the variable which controls E_O . This type of control is referred to as "VOLTAGE PROGRAMMING" and is covered in Par. 3-35.
- f) Many other modes of control are of course possible; some of them are described in the following paragraphs. For a more extensive treatment and a detailed theoretical view of power supply applications, see the "Kepco Power Supply Handbook", available from your Kepco Representative or directly from the Kepco Applications Engineering Department.

NOTE: For all programming and adjustment components, use high quality, wire-wound, resistors with a T.C. of 20 p.p.m. or better.

3-12 ADJUSTMENTS FOR EXACT PROGRAMMING RATIO

3-13 Referring to Equation (3): $E_O = I_b R_{VC}$, it is obvious that if $I_b = 1$ mA, for each volt of output voltage E_O , 1000 ohms of Control Resistance R_{VC} is needed. The "Programming Ratio" of 1000 ohms per volt is therefore based on the bridge current, I_b .

In the PCX and PCX-MAT Power Supplies, this bridge current (I_b) is about 10% higher than 1 mA.

Again referring to $E_o = I_b R_{vc}$ (3), we see that if R_{vc} is made zero (shorted out), E_o should be zero. However, a small negative offset voltage will be found at the output under this condition.

Both "inaccuracies", the small offset voltage as well as the slightly larger bridge current, have been purposely designed into the PCX and PCX-MAT Power Supplies in order to simplify precision adjustment of the Programming Ratio.

Quite a number of methods are possible towards that end. The accuracy of the calibration is only limited by the precision of the test equipment in the laboratory. Since the availability of this equipment will vary from laboratory to laboratory, several procedures are described in the following paragraphs.

NOTE: The external control rheostats (R_T = "External I_b Control" and R_Z "External Zero Control") may be omitted in the following procedures and diagrams if the PCX or PCX-MAT power supply has these controls built-in. See appropriate notes in the "Equipment Required" paragraph of each procedure and in FIG.'s 3-4, 3-5 and 3-6.

3-14 METHOD #1 (ACCURACY DEPENDS ON MILLIAMMETER AND R_{vc})

3-15 EQUIPMENT REQUIRED:

- Precision milliammeter, Weston Model 931 or equivalent. (M2)
- Precision resistor 1 K ohm $\pm 0.5\%$ or better. (R_{vc})
- Multimeter or other voltmeter for null indicator. (M1)
- Single pole, single throw switch. (SW-1)
- Rheostat (external " I_b " control) 0-1K (R_T) (May be omitted if Model has "R" suffix.)
- Rheostat (External Zero Control) 0-200 Ω (R_Z). (May be omitted if Model has "E" suffix).

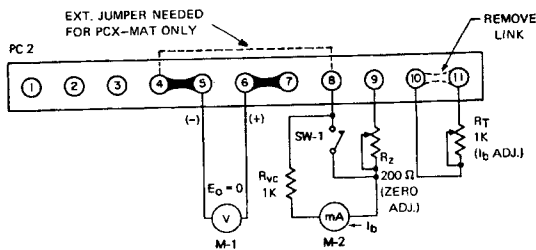

FIG. 3-4 PROGRAMMING RATIO CALIBRATION METHOD #1

3-16 PROCEDURE:

- Connect calibration set-up as shown in FIG. 3-4.
- Connect PCX or PCX-MAT Power Supply to AC input source. With SW-1 open, approximately 1 volt will be read at the output voltmeter, M-1.
- Adjust R_T (Ext. I_b control) until milliammeter M-2 reads exactly 1 mA.
- Disconnect power supply from the AC input source and mark zero reading of output voltmeter and reconnect to line.
- Close SW-1 and adjust R_Z (External zeroing control) exactly to this established zero point.
- Repeat (c),(d), and (e) until no further change is observed.

3-17 METHOD #2 (ACCURACY DEPENDS UPON CELL AND R_{vc})

3-18 EQUIPMENT REQUIRED:

- Mercury cell, 1.35 V.
- Precision resistor 1.35 K $\pm 0.1\%$. (R_{vc})
- Multimeter or other voltmeter as a null indicator. (M1)
- DPDT switch. (SW-1)
- Rheostat (external I_b adjustment) 0-1 K (R_T) (May be omitted if Model has "R" suffix).
- Rheostat (External zero adjustment) 0-200 Ω (R_Z) (May be omitted if Model has "E" suffix).

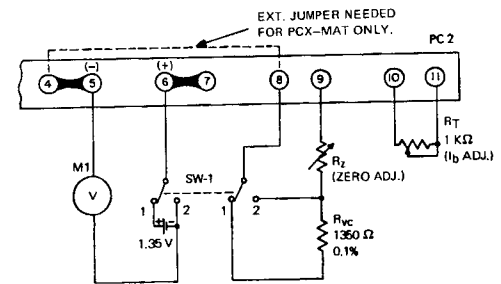

FIG. 3-5 PROGRAMMING RATIO CALIBRATION, METHOD #2

3-19 PROCEDURE

- Connect calibration set-up as shown in FIG. 3-5
- Connect power supply to AC input source. With SW-1 in Pos. 1, adjust R_T (external I_b control) to zero volts on the null meter.
- Transfer SW-1 to Pos. 2. Adjust R_Z (External zero control) to zero volts on the null meter.
- Return SW-1 to Pos. 1 and repeat (b) and (c) again until no further change is observed on the voltmeter.

3-20 METHOD #3 (ACCURACY DEPENDS ON VOLTMETER AND R_{VC})

3-21 EQUIPMENT REQUIRED:

- Precision differential - or digital voltmeter. (M1)
- A precision resistor ($\pm 0.1\%$), equal to $1000 \times E_O$ maximum (R_{VC}).
- Single Pole, single throw switch (SW-1)
- Rheostat (External I_b control) 0-1K (R_t) (May be omitted if Model has "R" suffix).
- Rheostat (External Zero Control) 0-200 Ω (R_z) May be omitted if Model has "E" suffix.

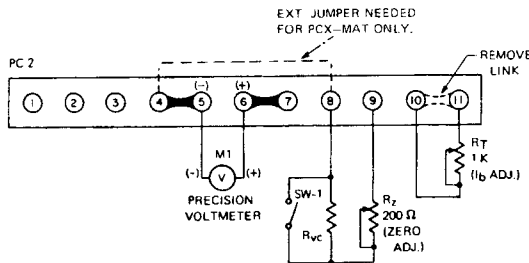

FIG. 3-6 PROGRAMMING RATIO CALIBRATION METHOD #3

3-22 PROCEDURE

- Connect calibration set-up as shown in FIG. 3-6.
- With SW-1 closed, adjust R_z (External zero control) for zero volts on the precision voltmeter.
- Open SW-1 and adjust R_t (External I_b control) exactly 1 volt per 1000 ohms.
- Repeat (b) and (c) until no further change is observed on the voltmeter.

3-23 PROGRAMMING OUTPUT VOLTAGE WITH RESISTANCE

3-24 The output voltage of the PCX or PCX-MAT Power Supply can be varied by means of a control resistance connected between terminals (8) and (9) of the barrier strip. This resistance may be fixed, continuously adjustable, or stepped,* or it may be a combination of these.

The value of the output voltage is given by Equation (1):

$$E_O = R_{VC} \frac{E_r}{R_r}$$

Since $\frac{E_r}{R_r} = I_b$ (Eq.2), it follows that

$$E_O = I_b R_{VC} \text{ (Eq.3)}$$

Referring to Equation (3), we see that since I_b is 1 mA in the PCX supplies (and can be precisely adjusted as shown in Par. 3-12), for every volt of output, 1000 ohms control resistance must be provided. This corresponds to a "Programming Ratio" of 1000 ohms per volt.

*NOTE: When fixed resistors are switched as the voltage control resistance, the switching device must have "Make before break" contacts in order

that the control circuit does not open during transfer. While the steady-state current through R_{VC} is only 1 mA, it will rise to considerably higher peak values when large voltage steps are programmed. The programming resistors must absorb these peak currents which consist of energy stored in the output capacitor. Consequently, it is recommended that the dissipation rating of the programming resistors is increased to several times the steady state power dissipated in them.

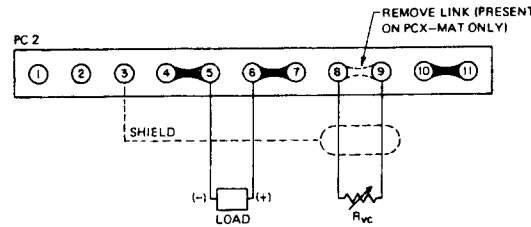

FIG. 3-7 CONNECTIONS FOR RESISTANCE PROGRAMMING

3-25 PROCEDURE (Refer to FIG. 3-7) PCX-MAT MODELS ONLY

- Disconnect the internal voltage control on PCX-MAT Models by removing the jumper link between terminals (8)-(9). (PCX Models do not have a link between these terminals). There are two ways to connect the external R_{VC} to the PC2 barrier strip:
 - Connect R_{VC} between terminals (4) and (9).
 - Connect R_{VC} between terminals (8) and (9) and place a jumper on the PCB board as shown in FIG. 5-2. This method may be used for existing installations where Models PBX-MAT are replaced with PCX-MAT.
- Determine value of programming resistor(s) for output voltage desired.
- Using two-wire, shielded cable, connect the chosen resistors to terminals (8) and (9). Connect the shield to terminal (3).
- The output voltage will vary from zero to $(1 \text{ mA}) \times (R_{VC})$, as R_{VC} is adjusted from zero to its maximum value.

3-26 CONSTANT CURRENT OPERATION

3-27 In the constant current operating mode, the voltage comparison bridge is interconnected with an external current sensing resistor, R_s and a current control, R_{CC} , (as shown in FIG. 3-8) to maintain a constant voltage drop across R_s . In this way, an adjustable constant load current is obtained. Characteristic of the constant current supply is the ability to change its output voltage automatically in order to maintain a constant current through a range of possible load resistances. The range of output voltage that the supply can deliver and simultaneously maintain constant current, is referred to as the "COMPLIANCE VOLTAGE".

3-28 The current sensing resistor R_S is chosen to develop a 1 volt drop at the maximum desired current. It is calculated by dividing this current into one volt. The value of R_S is not critical and can be the nearest standard resistance available. Several facts should be kept in mind however, when choosing R_S . A compromise must be made between a large and a small value. While a large value is desirable for good current regulation, it is less so in view of the power dissipated across it. It must be remembered that all the load current is flowing through R_S and the input to the regulator is connected across it. It is therefore vital that all extraneous changes across R_S , i.e. resistance change due to temperature, are kept to a minimum. A high quality, low T.C. (20 PPM) resistor, at least ten times the actual wattage needed, is therefore strongly recommended.

3-29 The current control resistor, (R_{CC}), is chosen on the basis of the control ratio of the Kepco comparison bridge, and V_S , the maximum voltage across R_S . If R_S was selected for 1 volt drop, then $V_S = 1$ Volt and $R_{CC} = V_S \times (\text{control ratio})$,

$$\text{or } R_{CC} = 1 \text{ volt} \times \left(\frac{1000 \text{ ohm}}{1 \text{ volt}} \right) = 1000 \text{ ohms.}$$

A high quality, low T.C. (20 PPM) resistor is recommended for R_{CC} .

3-30 PROCEDURE (Refer to FIG. 3-8)

The actual set-up procedure for current regulation is perhaps best shown by a practical example. A PCX 72-0.3 MAT is to be set up for current regulated output from 30 mA to 300 mA.

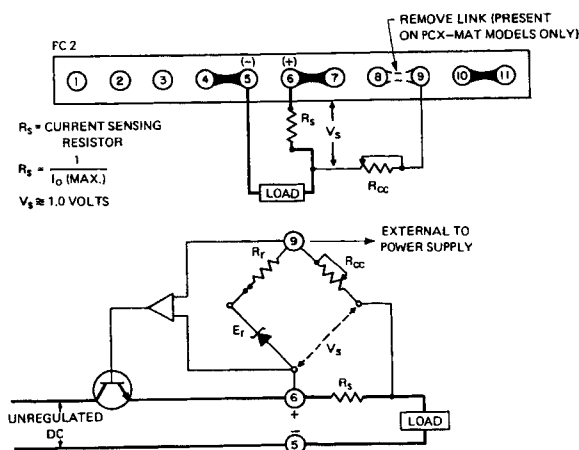

FIG. 3-8 CONNECTIONS FOR CONSTANT CURRENT OPERATION

a) R_S is chosen by: $R_S = \frac{1 \text{ volt}}{0.3 \text{ A}} = 3.33 \text{ ohm}$

$$P_{\text{diss}} = V_S \times I_{\text{max.}} = 1 \text{ volt} \times (0.3 \text{ A}) = 0.3 \text{ watts.}$$

b) The control resistance R_{CC} is found by calculating its limits:

$$R_{CC} (\text{max.}) = V_S (\text{max.}) \times \text{control ratio} =$$

$$1 \text{ V} \times \frac{1000 \text{ ohms}}{1 \text{ V}} = 1000 \text{ ohms.}$$

$$R_{CC} (\text{min.}) = V_S (\text{min.}) \times \text{control ratio} =$$

$$0.1 \text{ V} \times \frac{1000 \text{ ohms}}{1 \text{ V}} = 100 \text{ ohms.}$$

As R_{CC} is therefore varied from 100 ohms to 1000 ohms, the regulated current will vary from 30 to 300 mA, and the compliance voltage from approximately zero to 71 volts.

c) Since, in the above example, the sensing voltage across R_S went below 1 volt at the low current output, the current regulation may not be sufficient for the purpose intended. (Specifications are based on 1 volt sample). To insure regulation figures within specifications, we must calculate R_S under minimum current conditions.

$$V_S \text{ min.} = 1 \text{ volt}$$

$$R_S = \frac{1 \text{ volt}}{0.03 \text{ A}} = 33.3 \text{ Ohms}$$

$$I_{\text{min.}} = 0.03 \text{ A}$$

The actual power dissipation of R_S is given by:

$$P_{\text{diss}} = V_S (\text{max.}) \times I_L (\text{max.}) = 10 \text{ V} \times 0.3 \text{ A} = 3 \text{ watts.}$$

(Three 100 ohm, 10 W, wire-wound resistors connected in parallel, will be satisfactory.)

R_{CC} will now be:

$$R_{CC} (\text{max.}) = V_S (\text{max.}) \times \text{control ratio} = 10 \text{ V} \times 1000 \text{ ohm/V} = 10 \text{ K ohm.}$$

$$R_{CC} (\text{min.}) = V_S (\text{min.}) \times \text{control ratio} = 1 \text{ V} \times 1000 \text{ ohm/V} = 1 \text{ K ohm.}$$

3-31 PROGRAMMING BY CONDUCTANCE

3-32 For special applications, the output voltage E_O can be adjusted by varying the bridge current. The relationship governing this type of programming is:

$$E_O = E_r (R_{VC}) (G), \text{ or } E_O = \frac{E_r}{R_r + R_x} (R_{VC})$$

$$\text{Where: } G = \frac{1}{R_r + R_x} = \text{programming conductance}$$

E_O = output voltage

E_r = reference voltage

R_{VC} = control resistance

R_r = reference resistance

R_x = programming resistor

Since $\frac{E_r}{R_r} = I_b$ and $E_O = I_b R_{VC}$, the output voltage

varies directly as I_b changes. Changing I_b with the help of an additional resistor in series with R_r results in an inversely proportional change of I_b , since now

$$I_b = \frac{E_r}{R_r + R_x}.$$

This method of output voltage adjustment is therefore referred to as conductance programming.

3-33 Conductance programming is inherently non-linear and a reciprocal function when analyzed in terms of resistance. It can however be very useful, especially over a limited range and for small changes in output voltage. Another distinctive advantage of this type of programming is the "built-in" safety feature. Should the programming circuit open accidentally, the programming resistance becomes infinite, the conductance is zero, and consequently, the output voltage becomes zero.

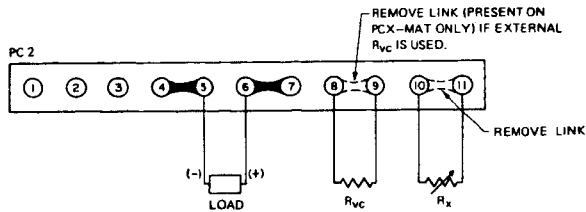

FIG. 3-9 CONNECTIONS FOR CONDUCTANCE PROGRAMMING

3-34 PROCEDURE

Example: E_o desired = 3 to 5 volts.

- a) Select R_{vc} for maximum desired output voltage E_o .

$$R_{vc} = \frac{E_o}{I_b}, \quad R_{vc} = \frac{5 \text{ V}}{1 \text{ mA}} = 5 \text{ K ohms}$$

- b) A change of E_o to 3 volts requires a bridge current change of:

$$\Delta I_b = \frac{\Delta E_o}{R_{vc}} = \frac{2 \text{ volts}}{5 \text{ K ohms}} = .4 \text{ mA}$$

- c) Since $I_b = \frac{E_r}{R_r} = 1 \text{ mA}$,

the additional resistance needed is:

$$I_b (R_r + R_x) = E_r, \quad R_x = \frac{E_r}{I_b} - R_r \text{ or}$$

$$R_x = \frac{6 \text{ volts}}{0.6 \text{ mA}} - 6 \text{ K} = 4 \text{ K ohms.}$$

A 4K ohm, WW, low T.C. potentiometer will change the output voltage from 3 to 5 volts when varied from zero to 4K ohms.

NOTE: A word of caution may be in order in regard to the changing of the bridge current. The 1 mA value has been selected for greatest stability in the zener reference circuit. A large departure from this value is not advisable. If a $\pm 50\%$ change in I_b is not sufficient to achieve the desired voltage swing, an external reference supply can be used.

3-35 PROGRAMMING OUTPUT VOLTAGE WITH EXTERNAL VOLTAGE

3-36 The output voltage (E_o) of the PCX-MAT Power Supply can be varied by means of another external voltage source. This external programming voltage supplies the control current (I_b) formerly delivered by the internal reference

voltage of the PCX supply. The output voltage (E_o) "follows" the programming source and maintains a value that remains in a constant proportion to it. The relationship governing this type of programming can be expressed by the equation:

$$E_o = E_i \frac{R_{vc}}{R_i}$$

- Where: E_o = output voltage to be programmed.
- E_i = programming voltage (input).
- R_{vc} = voltage control resistance of the supply to be programmed. (R_{vc} can be either internally or externally connected).
- R_i = external programming resistor (coupling resistor).

3-37 The values of the above quantities can be chosen to suit the particular application, although a few basic facts must be considered concerning their selection. E_o is, of course, limited by the maximum capability of the supply to be programmed. E_i can be any variable DC source having parameters at least as good as the desired E_o , and being able to deliver the necessary I_b . The resistors R_i and R_{vc} are selected by first determining I_b , desired bridge current. Since I_b is supplied by E_i and also subtracts from the load current of the supply to be programmed, it should be kept as low as possible, but not under $100 \mu A$.

3-38 Once I_b is selected and E_i as well as the desired output voltage E_o are known, R_{vc} and R_i are calculated by these simple relations:

$$R_{vc} = \frac{E_o}{I_b} \quad (2) \quad \text{where } I_b = \frac{E_i}{R_i} \quad (4) \quad \text{and}$$

$$E_o = \frac{E_i}{R_i} \times (R_{vc})$$

Stability, more than accuracy is the dominant criterion for selecting R_{vc} and R_i since part of the resistance can be made adjustable to compensate for tolerances and off-set voltages. Another important consideration in selecting control and programming resistors is to leave a wide safety margin when determining their wattage rating and to use only low temperature coefficient units.

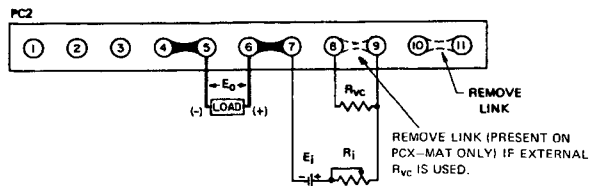

FIG. 3-10 CONNECTIONS FOR VOLTAGE PROGRAMMING

3-39 PROCEDURE (Refer to FIG. 3-10)

- a) Connect components as shown in FIG. 3-10, disconnect link between terminals (10) and (11) on the barrier strip.

- b) Component selection may be shown in the form of an example.

Example:

A PCX 40-0.5 MAT is to be programmed from zero to 30 V.

The programming source available is a variable 10 volt source, capable of delivering 5 mA. The bridge current is chosen to be 5 mA. We find R_{VC} and R_i by using equations (3) and (4).

$$(3) R_{VC} = \frac{E_o}{I_b} = \frac{30 \text{ V}}{5 \text{ mA}} = 6 \text{ K}$$

$$(4) R_i = \frac{E_i}{I_b} = \frac{10 \text{ V}}{5 \text{ mA}} = 2 \text{ K}$$

Power dissipated in

$$R_{VC} = 30 \text{ V} \times 0.005 \text{ A} = .15 \text{ W (use 1 W),}$$

Power dissipated in

$$R_i = 10 \text{ V} \times .005 \text{ A} = .05 \text{ W (use .5 W),}$$

3-40 SERIES OPERATION OF PCX-MAT MODULES

- 3-41 General. Kepco PCX-MAT Modules can be series connected for increased voltage output, provided the specified limits on voltage to chassis are not exceeded. When series-connected, the supplies should be protected by means of a semiconductor diode across the output terminals of each power supply, as shown in FIG. 3-11. The peak inverse rating of these diodes must be at least as large as the output voltage of the supply to which they are connected. The continuous current rating of the diodes should be at least as great as the largest short-circuit current of the interconnected supplies.

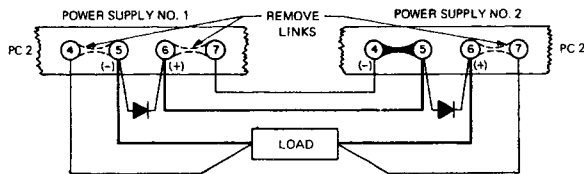

FIG. 3-11 SERIES CONNECTION OF PCX SUPPLIES

3-42 PROCEDURE

- Connect load as shown in FIG. 3-11. Keep voltage drop in load wires as low as practical by using heavy gauge wire.
- Connect protective diodes across respective output terminals.
- Remove jumpers as shown and connect error sensing leads. These leads carry negligible current and can be approximately #18 gauge wire.
- Turn supplies on and adjust voltage on either control as required.

3-43 PARALLEL OPERATION OF PCX-MAT MODULES

- 3-44 Two identical PCX-MAT power supplies may be operated in parallel for increased load-current output. Each supply is set to the desired output voltage with its respective Current Limiting Adjustment set to the maximum rated output current. After paralleling the two power supplies, one of the (supply #1) will inherently be at a slightly higher output voltage than the other (supply #2). Consequently, supply #1 will deliver all the load current up to the setting of its Current Limiting Adjustment. As the load is increased beyond this limit of supply #1, supply #2 takes over and delivers the additional current. The Current Limiting Adjustment of supply #1 can now be decreased, so that approximately equal current sharing is obtained. FIG. 3-12 shows in form of a diagram, how the two supplies operate in parallel, with their respective Current Limit Adjustments set to the maximum rated output current. It will be obvious from the diagram, that the areas of load regulation are within the output current bands of the individual supplies only. Therefore, load regulation cannot be measured from zero to twice the load current for example, but only within the individual load current bands. Error sensing as described in Par. 3-5, (from either supply) may be used if precise regulation at the load is required.

NOTE: When paralleling power supplies, care should be exercised to avoid turning the voltage control of only one supply close to zero. This precaution is necessary to prevent damaging currents in the voltage control resistor as its limiting resistance is lowered.

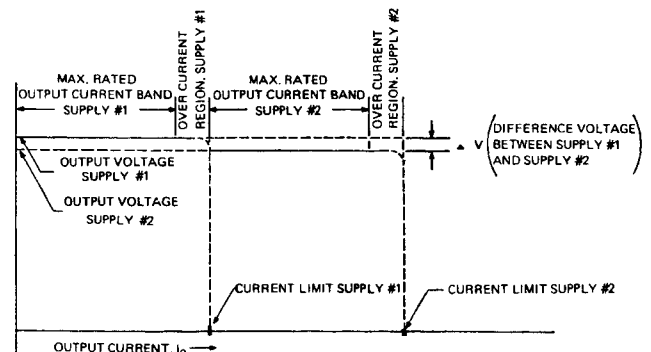

FIG. 3-12 PARALLEL OPERATION, PCX-MAT POWER SUPPLIES

3-45 PROCEDURE (Refer to FIG. 3-13)

- a) Connect units as shown in FIG. 3-13. Oper SW-1 and SW-2 and connect to AC input source.
- b) Close SW-1 and adjust both units to the approximate output voltage desired.
- c) Close SW-2. Observe load current meters M1 and M2. Adjust Current Limit Adjust potentiometer R19 on the unit showing the higher current on its load current meter. Turn R19 counter clockwise until currents on M-1 and M-2 are approximately equal.

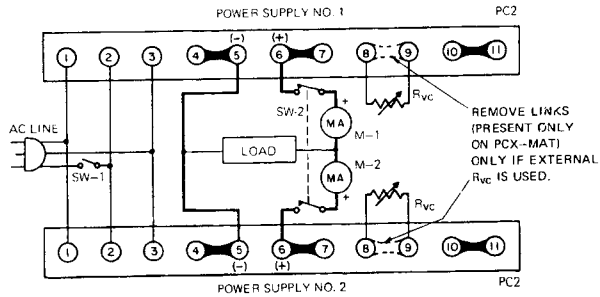

FIG. 3-13 PARALLEL CONNECTION OF PCX-MAT SUPPLIES

- 3-46 If single control of the parallel combination is desired, a master/slave connection may be substituted for the "automatic" parallel method shown in the previous paragraphs. If the two sensing resistors are selected such that $R_{S1} = R_{S2}$, each supply will deliver one half of the total load current. The sensing resistors should drop about 0.5 volt at the maximum operating current.

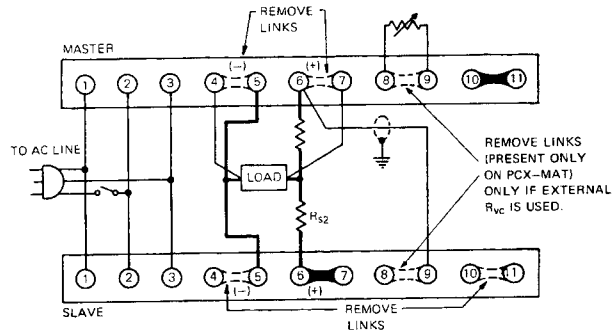

FIG. 3-14 MASTER/SLAVE PARALLEL CONNECTION